

////// ZERO-MAX[®]



Linear Actuators

Table of Contents

Roh'lix® Linear Actuators

Designed to convert rotary motion into linear motion, Roh'lix Linear Actuators are ideal for positioning operations in all types of machinery. They are available in 5 different sizes from 5 to 200 pounds thrust. Designed for easy installation, Roh'lix Linear Actuators provide up to 100 million inches of travel life with near zero backlash.

	<i>Page</i>
How Manufactured.....	3
Introduction	4
How They Work	5
Features/Benefits	5
Operating Characteristics	6
Life Expectancy/Installation.....	7
How To Select	8-9
Applications	9

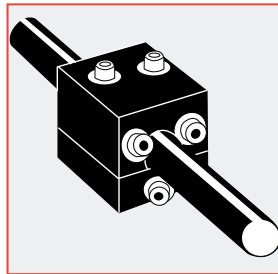

Phone Toll Free In The U.S. 1-800-533-1731 **or** 763-546-4300 **FAX** 763-546-8260

Thousands of Quality Zero-Max Products Are Used Every Second, Every Day, Somewhere In The World

For nearly half a century, Zero-Max has supplied industries around the world with millions of adjustable speed drives, right angle gear drives and linear actuators. These products are designed to accurately assist in controlling demanding machine processes.

From precise adjustable speed drives used in conveyors, to right angle gear drives used in large printing presses, to linear actuators used in special machines to make styrofoam--there are Zero-Max products working hard and dependably every second of every day.

Large and small companies in most manufacturing industries have learned to depend on and trust Zero-Max motion control products.

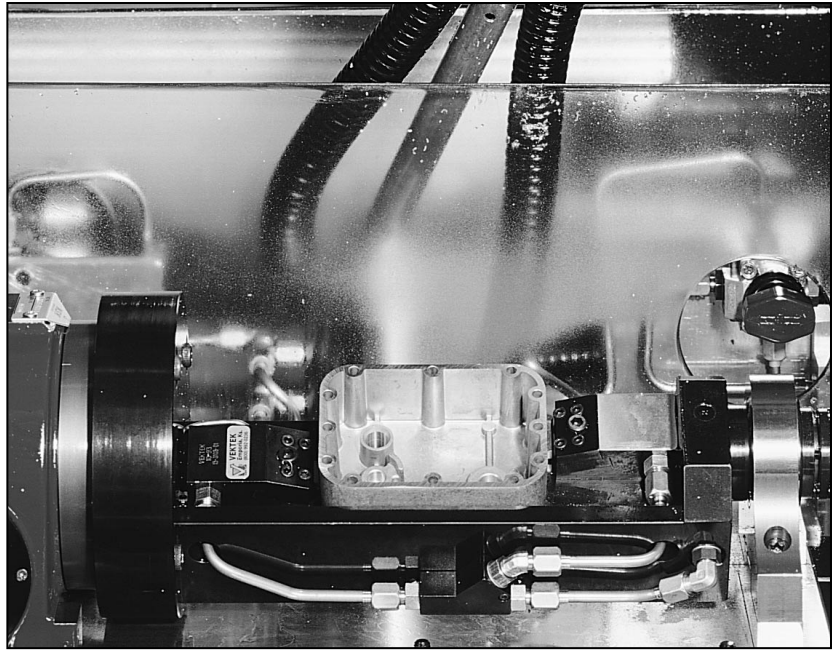

Roh'lix® Linear Actuators

are manufactured within tight tolerances to provide accurate linear travel with each shaft revolution. The Roh'lix principle allows the unit to slip when the thrust capacity is exceeded, thereby offering protection to other components in the power train.



Roh'lix[®] Linear Actuators

The Roh'lix Linear Actuator is a device that converts rotary motion into linear motion. The Roh'lix uses **rolling** element ball bearings that trace a **helix** pattern along the shaft, which produces a Rolling Helix, or **Roh'lix** for short. Available sizes have thrust capacities ranging from 15 to 200 lbs (67 to 889 Newtons), shaft diameters ranging from 3/8 to 2.00 inches (8 to 50 mm), and leads ranging from 0.025 to 6.00 inches (0.625 to 150 mm).

The Roh'lix Linear Actuator consists of six preloaded bearings that contact the shaft at an angle. When the shaft is rotated, the bearings trace out an imaginary screw thread, causing the Roh'lix to travel linearly along the shaft.

The thrust of the Roh'lix is established by spring force between the two block halves. The thrust force

is adjusted by the thrust adjustment screws on the top of the block, allowing the thrust setting to be fine-tuned to individual applications. When the thrust setting is exceeded, the Roh'lix slips on the shaft until the source of the overload is corrected. The ability to slip allows the Roh'lix to provide overload protection for the equipment on which it is used.

The amount of linear distance the Roh'lix travels per shaft revolution is called lead. The lead is determined by the angle of the bearings in the Roh'lix block. The Roh'lix can be manufactured with virtually any fixed lead up to 3 times the shaft diameter. The lead, in combination with the driveshaft speed, determines the linear travel rate. By changing either the lead or the driveshaft speed, you can change the rate of linear travel.

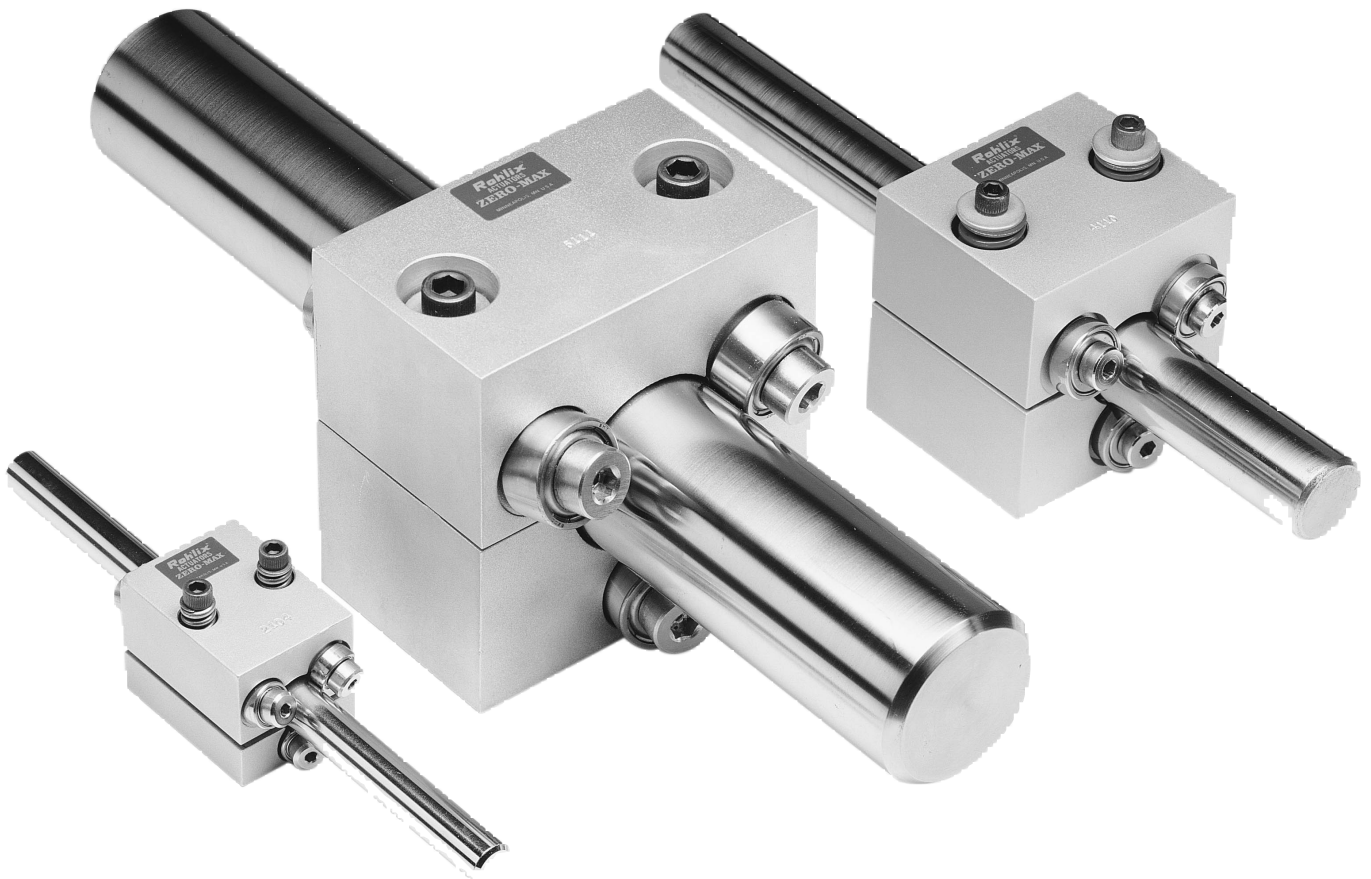

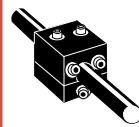

How Roh'lix® Linear Actuators Work

Roh'lix Actuators have six precision ball bearings, three at each end of a two-piece aluminum block.

Mounted at an angle relative to the drive shaft axis, the bearings convert drive shaft rotation into proportional linear travel. This is called lead. The linear thrust capability of the Roh'lix is determined by the friction between

the smooth surfaces of the angled bearings and the drive shaft.

Thrust capability is varied by adjusting the cap screws located on the top of the load block.

Loads exceeding the thrust setting cause the Roh'lix to stop while the bearings rotate in place as long as the drive shaft is turning.

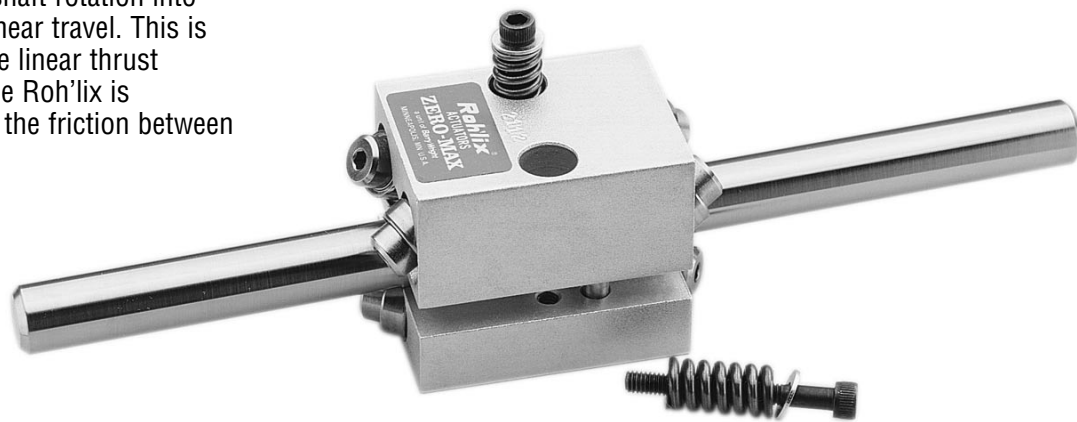

Check These Roh'lix® Actuator Advantages

Features	Benefits
5 different sizes, wide range of leads, various shaft diameters available.	Many units to choose from to get the right one for your application.
2-piece, split aluminum block.	Easy installation; the block halves can be assembled around the shaft without necessitating the removal of driveshaft and/or pillow-block bearings.
Overload protection.	Roh'lix has the ability to slip in the event of a jam-up, protecting product equipment.
Adjustable thrust setting.	Thrust can be set precisely to carry the load without slipping, but not so high that the Roh'lix builds up unnecessary thrust before overloading.
Six ball bearings	High efficiency – exceeding 90%. Long life; ranging from 2 million to 100 million inches of linear travel.
Coil springs for thrust adjustment.	Preloads bearings to minimize backlash to less than 0.001 inch. Minimal backlash stays consistent throughout the lifetime of the unit.
Socket-head shoulder screws to mount the bearings to the block.	Allows for easy bearing replacement.

Roh'lix® Operating Characteristics

Efficiency

The rolling contact between the outer races of the six ball bearings and the driveshaft provides a smooth, quiet linear motion, resulting in a minimum of 90% efficiency.

Backlash

Roh'lix bearings are preloaded by the coil springs to reduce backlash to less than 0.001 inch, which help maintain consistency throughout the life of the bearings.

Positioning Accuracy

The Roh'lix is a friction drive device and as a result, will show an accumulated error that is, in general, up to 0.002 inches per shaft revolution. Where greater accuracy is required, linear encoders can be used to indicate position.

Overload Protection

The Roh'lix has the ability to slip if an obstruction is encountered in the system. This unique advantage over other types of linear actuators can prevent damage and costly downtime.

Lubrication

Roh'lix bearings are factory-lubricated for life and are designed to run on a clean, non-lubricated driveshaft.

Shafting

Recommended driveshaft material is C-1060 hardened and ground shafting with a minimum hardness of HRC 58. Its hardness will provide optimum life expectancy and its ground surface provides a uniform friction surface. Stainless steel shafting, although slightly softer, is adequate for many applications requiring corrosion protection.

Temperature

Acceptable temperature range is -10°F to +180°F. Special units available for higher or lower temperatures.

Maintenance

Unit is maintenance free, however, the shafting may require occasional wiping to clean off foreign matter that may accumulate.

Backdriving

By applying a thrust load to the Roh'lix unit, the shaft can be made to rotate. The thrust load will cause the Roh'lix and any device attached to it to travel along the shaft. Therefore, the Roh'lix should never be relied upon as the sole device to hold position.

Tandem Roh'lix

Two Roh'lix may be used on a common shaft in series, or in parallel on separate shafts, however, the combined thrust rating must be derated by 20%. When installing the Roh'lix units, be sure to tighten the thrust adjustment screws an equal number of turns so that they share the thrust load equally.



Roh'lix® Operating Characteristics

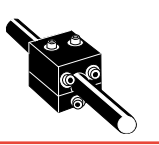

Roh'lix Life Expectancy

Roh'lix lifetime can range anywhere from 2 million to over 100 million inches of linear travel, depending on the application variables. The following factors should be considered to maximize the lifetime of Roh'lix:

Thrust: Roh'lix lifetime is increased when the application thrust load is a smaller percentage of the unit's thrust rating. Selecting an oversized Roh'lix is advisable to achieve the greatest lifetime of the unit.

Lead/Shaft Speed: Higher lead units will produce longer lifetime because fewer bearing revolutions will be required to move the same linear distance as a low lead unit. Also, reductions in the driveshaft RPM will increase lifetime. For a given linear speed, a higher lead will allow a lower shaft speed, and the two factors in combination will work to yield a greater lifetime.

Overloading: Occasional slippage for short periods of time is acceptable. However, frequent or extended periods of slippage will result in reduced lifetime of the bearings.

Other: Minimize sidualoads and twisting loads to gain maximum life from the Roh'lix.

Loading

The Roh'lix is intended for axial loading. Sidualoads and twisting loads (**Figure 1**) should be avoided whenever possible, as they cause uneven bearing loading and shorten lifetime.

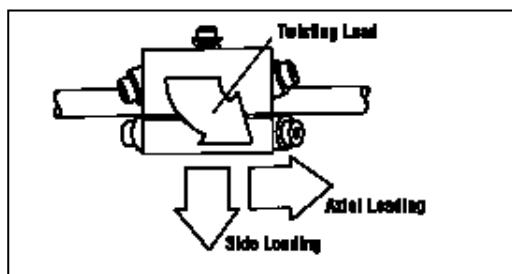

Figure 1

Whenever possible, the load weight on the Roh'lix should be supported by a separate linear bearing assembly. Where sidualoads cannot be avoided, the amount of the siduaload should be subtracted from the thrust capacity of the unit. The amount of the siduaload should never exceed 50% of the actuator's thrust capacity. If necessary, select an oversized Roh'lix to handle these application conditions.

Installation

The Roh'lix has a split-block for ease of installation. The two block halves can be assembled around the shaft, eliminating the need for removal of pillow-block bearings, coupling, etc. The split-block design is also a benefit for removal of the Roh'lix for service, such as bearing replacement.

Thrust Adjustment

Thrust of the Roh'lix is set by one of three methods:

- 1) Adjust the thrust adjustment screws in increasing amounts until thrust setting is enough to carry load without slipping. This allows slippage before an overload builds up an unnecessary thrust load causing reduced bearing life.
- 2) Use a spring scale to set the amount of thrust (**Figure 1**). This technique works where the thrust requirement is known.
- 3) Use the thrust per turn rating (**Figure 2**) to determine the appropriate number of turns of the thrust adjustment screws. This technique also works where the thrust requirement is known.

Model #	Screw Length	Screw Size	Thrust per Turn
1	1.25	6-32	3 lbs.
2	1.50	10-32	17 lbs.
3	2.00	1/4-20	25 lbs.
4	2.25	1/4-20	25 lbs.
5	2.50	3/8-16	35 lbs.

Figure 2

To set a given thrust on the Roh'lix, start with the thrust adjustment screws loose then tighten by hand until the screw head lightly touches the top of the spring. Tighten both adjusting screws one full turn. This will set the thrust as shown in the thrust column of **Figure 2**. Finish the thrust adjustment by turning the additional turns as necessary.

How To Select A Roh'lix® Linear Actuator

1. Determine Thrust Requirement.

Horizontal Applications: $F = \mu W$

Vertical Applications: $F = W + \mu W$

F = thrust requirement (Lbs.)

μ = Coefficient of friction

W = weight of load being moved (Lbs.)

2. Determine Lead/ Driveshaft Speed/ Linear Speed.

$$\text{Driveshaft RPM} = \frac{60 \times \text{Linear Speed}}{\text{Roh'lix Lead}}$$

Driveshaft RPM = speed of shaft driving the Roh'lix (RPM)

Linear Speed = travel rate of the Roh'lix (inches per sec.)

Roh'lix Lead = lead of the Roh'lix (inches per shaft revolution)

3. Select Roh'lix Model.

Choose a Roh'lix Model from **Figure 2a** or **2b** that has a thrust equal to or exceeding the thrust requirement determined in **Step 1** and lead that fits the driveshaft RPM and linear speed needs from **Step 2**.

4. Verify Shaft Diameter.

Driveshaft speed should be within the maximum recommended driveshaft speed shown in **Figure 3**.

If driveshaft speed is above the recommended speed, try changing one or more of the following:

- 1) Change the bearing mounted method to B or C to increase the maximum recommended driveshaft speed above the application requirement, or
- 2) Change to hollow shafting, which will increase the maximum recommended speed by approximately 50% above ratings shown in **Figure 3**, or
- 3) Select a higher lead Roh'lix to reduce the shaft speed requirement, yet still maintain the desired linear travel rate.

Inch Models

Size	Model Number	Shaft dia. (In)	Lead (In)	Thrust Rating (Lb)
1	1104	3/8	.03	15
	1111	3/8	.10	15
2	2102	3/8	.10	30
	2114	3/8	.20	30
	2103	3/8	.50	30
	2101	1/2	.10	30
	2115	1/2	.20	30
	2104	1/2	.50	30
	2112	1/2	1.00	30
	3	3123	1/2	.20
3109		1/2	.50	60
3128		1/2	1.00	60
3110		5/8	.10	60
3145		5/8	.50	60
3103		3/4	.10	60
3107		3/4	.75	60
3133		3/4	1.00	60
4		4118	1	.20
	4110	1	.50	100
	4111	1	1.00	100
	4125	1	2.00	100
5	5106	1-1/2	1.00	200
	5109	2	.38	200
	5112	2	3.00	200

Figure 2a

Metric Models

Size	Model Number	Shaft dia.	Lead (mm)	Thrust Rating (newton)
1	1901	8	1.3	67
	1902	8	2.5	67
2	2901	8	2.5	133
	2902	8	15.0	133
	2903	12	5.0	133
	2904	12	15.0	133
	2905	12	25.0	133
	3	3901	12	2.5
3902		12	10.0	266
3913		16	2.5	266
3914		16	15.0	266
3915		16	25.0	266
4	4901	25	2.5	444
	4902	25	5.0	444
	4903	25	25.0	444
5	5901	40	10.0	889
	5902	50	5.0	889
	5903	50	50.0	889

Leads are available from a minimum of 0.025 inch (.625mm) to maximum of 3 times the shaft diameter. Drive shaft diameters may be as small as 3/8 inch to as large as 2 inches. (8 to 50 mm)

Figure 2b

Special Models

Stainless steel hardware and bearings may be supplied along with a clear chromated block for use in corrosive atmospheres in sizes 1 through 4, however thrust rating must be derated by 25%.

Anodized or stainless steel blocks are not available.

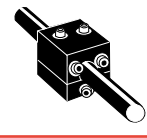

How To Select A Roh'lix® Linear Actuator

Maximum Recommended Drive Shaft Speed

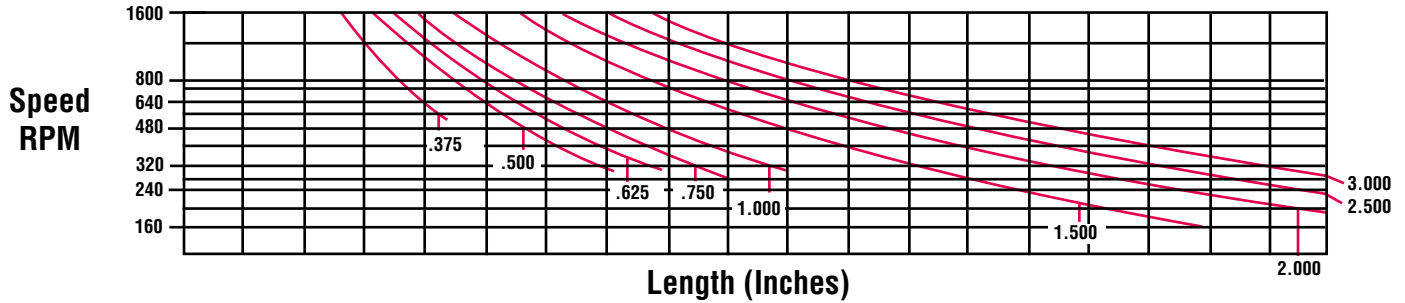
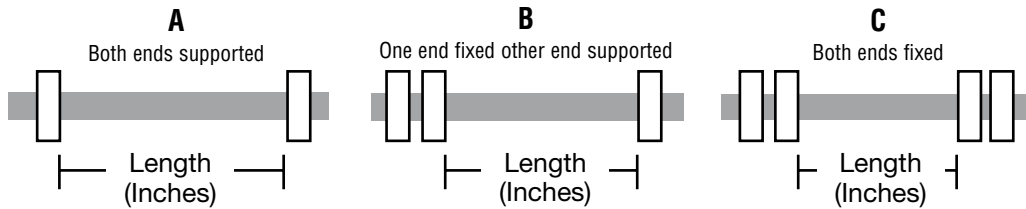

Figure 3

A	10	20	30	40	50	60	70	80	90	100	110	120	130	140	150	160	170	180	190
B	12	25	35	50	60	70	85	100	110	120	130	145	160	170	180	195	205	220	230
C	15	30	40	60	75	90	105	120	135	150	165	180	195	210	225	240	255	270	285

Bearing Mounting Method



Roh'lix Sizes 1-5

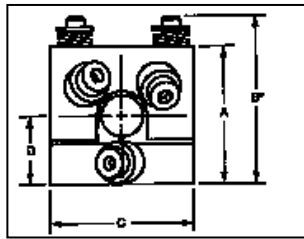
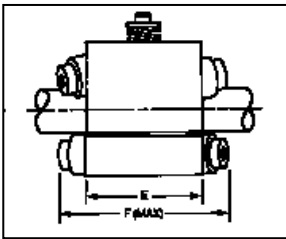

Roh'lix Sizes 1-3

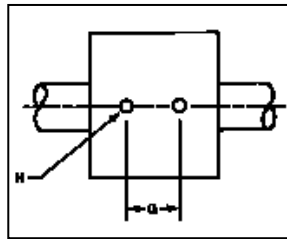

Roh'lix Sizes 4-5

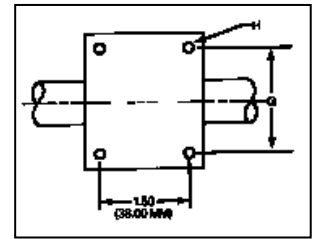

Size	Dimensions							H-Tapped Mounting Holes
	A	B	C	D	E	F	G	
1	1.14	1.66	1.12	.57	1.62	2.25	.75	#6-32 UNC x 1/4 DP
	(29)	(42.2)	(28.6)	(14.5)	(41.3)	(57.2)	(19)	(M3 x 0.5 x 6.35 DP)
2	1.52	1.91	1.50	.76	2.00	2.81	1.00	#10-32 UNF x 3/8 DP
	(38.6)	(48.5)	(38.1)	(19.3)	(50.8)	(71.4)	(25.4)	(M5 x 0.08 x 9.53)
3	2.02	2.69	2.00	1.01	2.50	3.42	1.25	1/4-20 UNC x 1/2 DP
	(51.3)	(68.3)	(50.8)	(25.6)	(63.5)	(86.9)	(31.1)	(M6 x 1.0 x 12.7 DP)
4	3.00	3.50	3.00	1.50	2.50	3.56	2.50	1/4-20 UNC x 1/2 DP
	(76.2)	(88.9)	(76.2)	(38.1)	(63.5)	(90.4)	(63.5)	(M6 x 1.0 x 12.7 DP)
5	4.50	4.68	4.50	2.25	2.75	4.68	4.00	1/4-20 UNC x 1/2DP
	(114.3)	(118.9)	(114.3)	(57.2)	(69.9)	(118.9)	(101.6)	(M6 x 1.0 x 12.7 DP)

Dimension at Zero Thrust Setting. Dimensions in () are for metric models.

Typical Roh'lix Applications Include:

Core Cutter, Door Opener, CNC Lathe Feeder, Paint Sprayer, Adjustable Web Guides, Microfiche File, X-Y Positioning Table, Height Gauge, Optical Measuring Scanner, Inspection Table, Parts Feeder, Pick and Place Machine, Screen Printer, Robotic Gantry, Ink Agitator, Transfer Table, and Back Gauge.

Additional Zero-Max® Motion Control Products



CD® Couplings

New patented open arm coupling design uses composite material in disc packs.

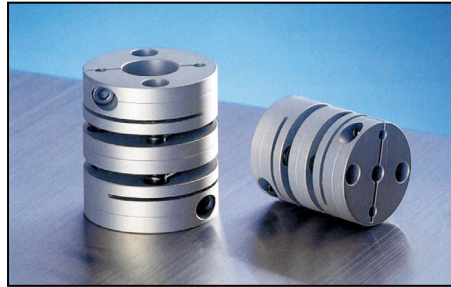

ServoClass® Couplings

Zero backlash, torsionally stiff, high misalignment servomotor couplings. 8 sizes, from 8 to 885 inch pound of torque.



Schmidt Couplings

In-line, Offset and Elastomeric couplings suitable for shaft to shaft applications.



Torq-Tender® Couplings

Torque limiting couplings up to 3000 inch pounds with limit switch actuators.

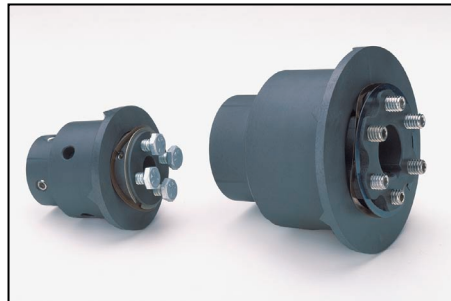

H-TLC Torque Limiters

Corrosion resistant. Bores from .250" to 1.000". Torques from 4 to 500 in. lbs.



ETP® Shaft Bushings

Hydraulic principle for precise and fast installation. 26 sizes from 3/4" to 4".



Posi-Lok® Shaft Bushings

Inch and Metric sizes to 35 mm. Nickel plating offers corrosion protection.

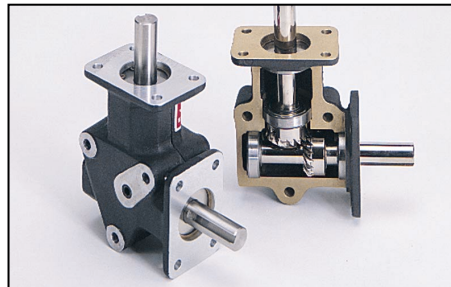

Crown Right Angle Gear Drives

Two and three way models with 1:1 and 2:1 ratios. Precise spiral bevel gears.

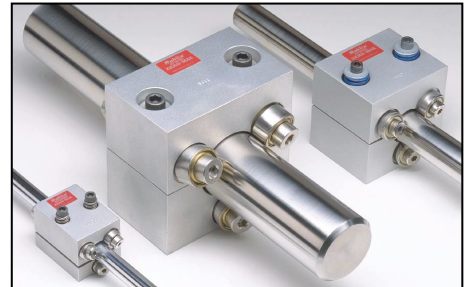

Roh'lix® Linear Actuators

Convert rotary motion into linear motion. Five models with 3/8" to 2" dia. shafts.

WARRANTY

Zero-Max, Inc. the manufacturer, warrants that for a period of 12 months from date of shipment it will repair, or at its option, replace any new apparatus which proves defective in material or workmanship, or which does not conform to applicable drawings and specifications approved by the manufacturer. All repairs and replacements shall be F.O.B. factory. All claims must be made in writing to the manufacturer.

In no event and under no circumstances shall manufacturer be liable for (a) damages in shipment; (b) failures or damages due to misuse, abuse, improper installation or abnormal conditions of temperature, dirt, water or corrosives; (c) failures due to operation, intentional or otherwise, above rated capacities, and (d) non-authorized expenses for removal, inspection, transportation, repair or rework. Nor shall manufacturer ever be liable for consequential and incidental damages, or in any amount greater than the purchase price of the apparatus.

Zero Max, Inc. reserves the right to discontinue models or to change specifications at any time without notice. No discontinuance or change shall create any liability on the part of Zero-Max, Inc. in respect to its products in the hands of customers or products on order not incorporating such changes even though delivered after any such change.

This warranty is in LIEU OF ALL OTHER WARRANTIES, EXPRESS OR IMPLIED, INCLUDING (BUT NOT LIMITED TO) ANY IMPLIED WARRANTIES OF MERCHANTABILITY OR FITNESS FOR A PARTICULAR PURPOSE. THE TERMS OF THIS WARRANTY CONSTITUTE ALL BUYER'S OR USER'S SOLE AND EXCLUSIVE REMEDY, AND ARE IN LIEU OF ANY RIGHT TO RECOVER FOR NEGLIGENCE, BREACH OF WARRANTY, STRICT TORT LIABILITY OR UPON ANY OTHER THEORY. Any legal proceedings arising out of the sale or use of this apparatus must be commenced within 18 months of the date of purchase.

CAUTION: Rotating equipment must be guarded. Also refer to OSHA specifications and recommendations.

Zero-Max®, CD®, ETP®, ServoClass®, Torq-Tender®, Control-Flex®, Posi-Lok® and Roh'Lix® are registered trademarks of Zero-Max, Inc. OHLA™ is a trademark of Zero-Max, Inc.

© Zero-Max 2000 DCR020010 Printed in U.S.A.

////// ZERO-MAX®

13200 Sixth Avenue North, Plymouth, Minnesota 55441-5509
800-533-1731 • (763) 564-4300 • Fax (763) 546-8260 • www.zero-max.com